

TAKE ME
ANYWHERE

nordlux®



Table of contents

03
**Take Me
Anywhere**

04
**Jim
To-Go**

06
**Temple
To-Go**

06
**Ara
To-Go**

08
**Bring
To-Go**

10
**Bob & Leo
To-Go**

12
**Ara
To-Go**

14
**Sponge
Series**

16
**Kettle
Series**

22
**Campaign
collaboration**

23
**In Store
Support**

24
**Marketing
Support**



Watch the full ambience video and explore the functionalities of the Take Me Anywhere assortment



Take Me Anywhere

Have you ever needed light at places with no power outlet? On the balcony, terrace or maybe under your favorite tree in the park? Imagine a piece of lighting that does not require electricity from a power outlet and can be placed freely anywhere in the home - both inside and outside.

The advantage of the built-in battery is not to be mistaken as numerous applications are created when no cables are needed. A beautiful light shines through the shade in three light levels and together with the durable materials, the perfect lighting for the outdoor spaces is created.

High functionality, newest LED technology and elegant Danish design comes together, which is why the portable lamp invites to 'Take Me Anywhere'.



Watch the full ambience video and explore the functionalities of the Jim series



Jim



Red
2218105002



Black
2218105003



Blue
2218105006



Grey
2218105010



Green
2218105023



Orange
2218105027

Jim To-Go by Says Who

- Masterbox** Qty 4
- Size** H: 30,3 cm, Ø: 28 cm, Shade Ø: 16 cm,
- Material** Metal/Plastic
- IP Class** IP54, Class 3 (12V)
- Cable** Black 100 cm,
Switch: On the base
- Lightsources** LED Module - 300 Lumen, 2700 Kelvin, 30000 Hours,
Has built-in dimmable light source with Moodmaker™ functionality

- Features**
- Easy to bring everywhere (battery powered)
- High lumen output (300 lumen)
- 3-step Moodmaker™



Long life battery



Step dimming on the product



USB charge

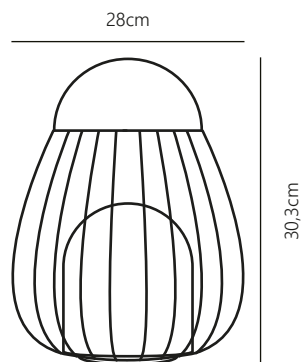



Watch the full ambience video and explore the functionalities of the Temple series



Temple



Galvanized
2218325031



Brass
2218325035

Temple 30 To-Go by Says Who

Masterbox	Qty 3
Size	H: 22,2 cm, W: 22,6 cm, L: 22,6 cm, Shade Ø: 22,6 cm, Base Ø: 13,8 cm,
Material	Galvanized/Brass
IP Class	IP54, Class 3 (12V)
Lightsource	3000K Kelvin,

Features

- Durable materials well-suited for harsh weather
- Solar charged
- High light output (300 lumen)
- Turns on automatically when darkness falls

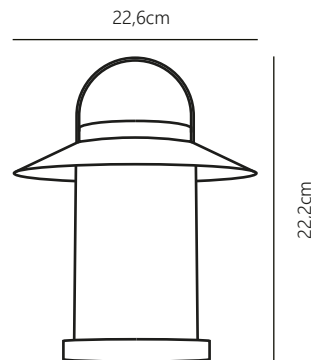
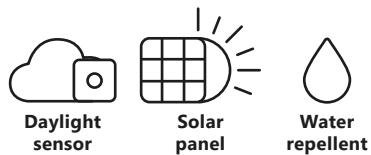

Galvanized
2218335031



Brass
2218335035

Temple 35 To-Go by Says Who

Masterbox	Qty 3
Size	H: 30,4 cm, W: 31,3 cm, L: 31,3 cm, Shade Ø: 31,3 cm, Base Ø: 19 cm,
Material	Galvanized/Brass
IP Class	IP54, Class 3 (12V)
Lightsource	3000K Kelvin

Features

- Durable materials well-suited for harsh weather
- Solar charged
- High light output (300 lumen)
- Turns on automatically when darkness falls

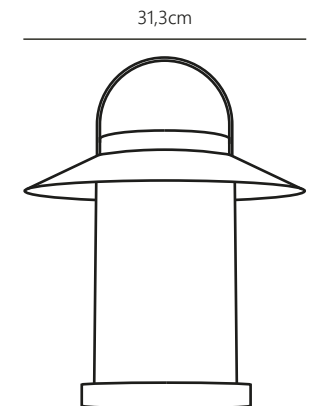
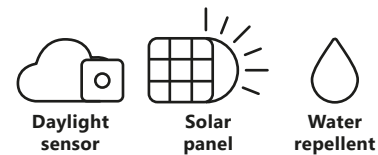



Watch the full ambience video and explore the functionalities of the Bring series



Bring



White
2218013001

Bring 12 To-Go by Timothy Jacob Jensen Studios

Masterbox	Qty 3
Size	H: 12 cm, Ø: 12 cm, Shade Ø: 12 cm,
IP Class	IP44, Class 3 (12V)
Cable	Black 70 cm,
Lightsource	LED Module, 70 Lumen, 2700K Kelvin, 25000 Hours, Has built-in dimmable light source with Moodmaker™ functionality

Features

- Easy to bring everywhere (battery powered)
- Made from recycled materials
- Water resistant (IP65)
- Just tap to turn on/off
- USB cable for charging included
- Long battery life

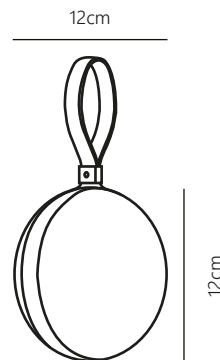

White
2218023001

Bring 16 To-Go by Timothy Jacob Jensen Studios

Masterbox	Qty 3
Size	H: 16 cm, Ø: 16 cm, Shade Ø: 16 cm,
IP Class	IP44, Class 3 (12V)
Cable	Black 70 cm,
Lightsource	LED Module, 120 Lumen, 2700K Kelvin, 25000 Hours, Has built-in dimmable light source with Moodmaker™ functionality

Features

- Easy to bring everywhere (battery powered)
- Made from recycled materials
- Water resistant (IP65)
- Just tap to turn on/off
- USB cable for charging included
- Long battery life

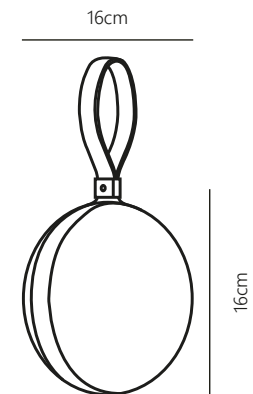

Leo



Watch the full ambience video and explore the functionalities of the Bob & Leo series



Bob



FSC Bamboo
2118085062



FSC Bamboo
2118085062

Bob To-Go by Says Who

Masterbox	Qty 2
Size	H: 39,6 cm, W: 29,4 cm, L: 31,8 cm
Material	Bamboo/Plastic
IP Class	IP44, Class 3
Cable:	Black 100 cm replaceable, Switch on fixture
Light source	SOLAR LED, Incl. 4W LED, Lumen 300, Kelvin 2700, Life hours 30.000, RA 80, Beam angle 240°, Not dimmable

Features

Solar charged
High light output (300 lumen)
Turns on automatically when darkness falls
30 cm high (suitable for Kettle spike and tripod)
FSC approved bamboo

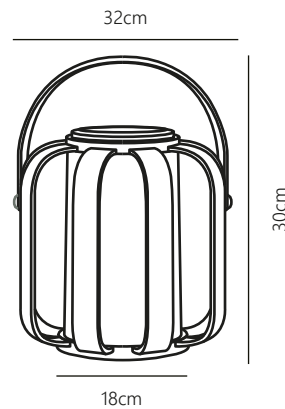
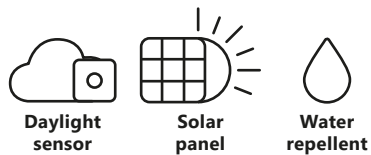

Leo To-Go by Says Who

Masterbox	Qty 2
Size	H: 30 cm, Ø: 29,9 cm, Base Ø: 18 cm
Material	Bamboo/Plastic
IP Class	IP44, Class 3
Cable	Black 100 cm, Switch on fixture
Light source	SOLAR LED, Incl. 4W LED, Lumen 300, Kelvin 2700, Life hours 30.000, RA 80, Beam angle 240°, Not dimmable

Features

Solar charged
High light output (300 lumen)
Turns on automatically when darkness falls
30 cm high (suitable for Kettle spike and tripod)
FSC approved bamboo

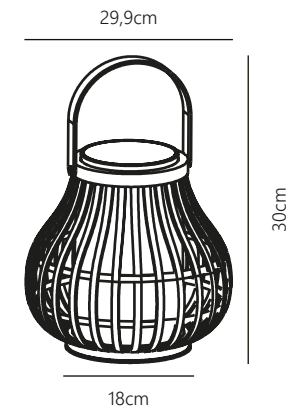
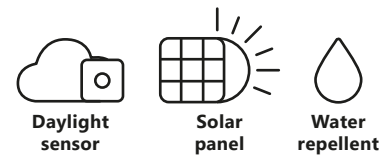



Watch the full ambience video and explore the functionalities of the Ara series



Ara



White
2118245001



Black
2118245003



Sand
2118245008

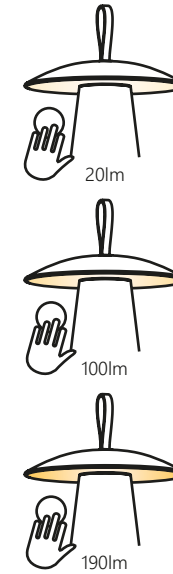

Ara To-Go

- Masterbox** Qty 3
- Size** H: 29,2 cm, Shade Ø: 19,7 cm
- Material** Aluminium/Plastic
- IP Class** IP54, Class 3
- Cable** White 100 cm non replaceable
- Light source** Fixed LED, Incl. 2W LED, Lumen 105, Kelvin 3000, Candela 730, Life hours 30.000, RA 80, Beam angle 125°, Not dimmable

Features

- Battery powered
- 3-step MoodMaker function
- Up to 80 hours of battery life
- 5 year LED guarantee



Long life battery



Step dimming on the product



USB charge

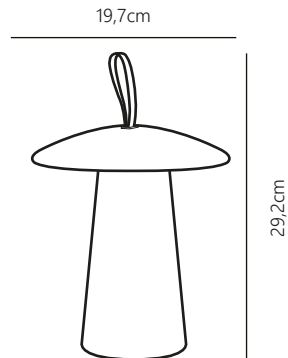



Watch the full ambience video and explore the functionalities of the Sponge series



Sponge



White
2018103003

Sponge Pendant by Says Who

Masterbox	Qty 3
Size	H: 55,4 cm, W: 20 cm, L: 20 cm, Ø: 20 cm, Shade Ø: 20 cm, Pipe Ø: 2,3 cm
Material	Plastic/Metal
IP Class	IP65, Class 3
Light source	Fixed LED, Incl. 4,8W LED, Incl. 3-Step MOODMAKER™, Lumen 300, Kelvin 2700, Life hours 30.000, RA 80, Beam angle 120°, Dimmable

Features

- Long life battery
- Durable materials
- High lumen output with 3 step dimming
- 5 year LED guarantee
- Warm white LED 2700 Kelvin
- Space saving pendant

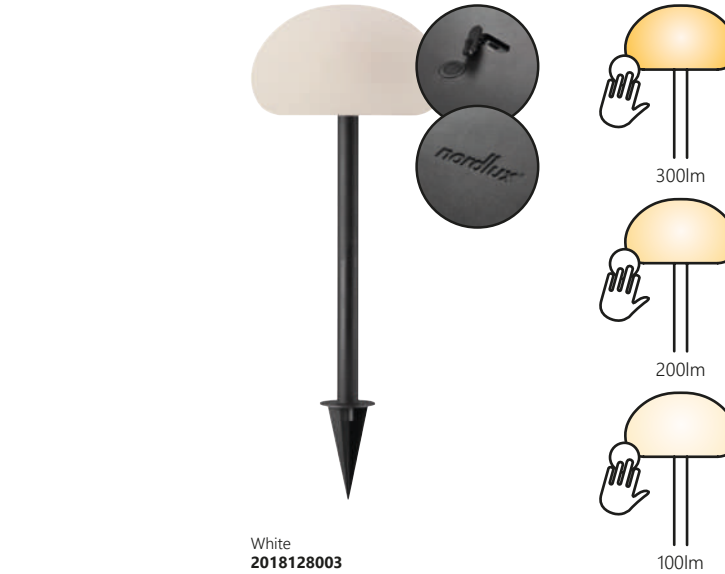
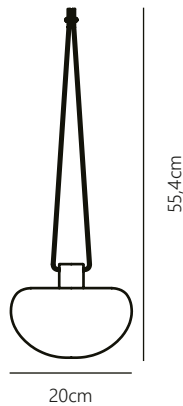

White
2018128003

Sponge Spike by Says Who

Masterbox	Qty 3
Size	H: 51,5 cm, W: 20 cm, L: 20 cm, Ø: 20 cm, Shade Ø: 20 cm, Pipe Ø: 2,3 cm
Material	Plastic/Metal
IP Class	IP65, Class 3
Cable	Black 150 cm replaceable, Switch on fixture
Light source	Fixed LED, Incl. 4,8W LED, Incl. 3-Step MOODMAKER™, Lumen 300, Kelvin 2700, Life hours 30.000, RA 80, Beam angle 120°, Dimmable

Features

- Long life battery
- Durable materials
- High lumen output with 3 step dimming
- 5 year LED guarantee
- Warm white LED 2700 Kelvin

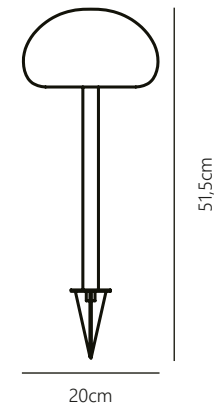



White
2018145003

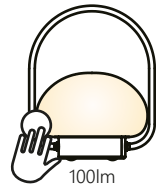
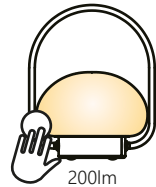
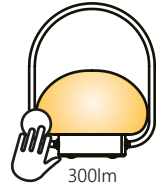

Sponge To-Go by Says Who

Masterbox	Qty 3
Size	H: 27,7 cm, W: 22,5 cm, L: 22,5 cm, Ø: 22,5 cm, Pipe Ø: 1 cm, Base Ø: 13,5 cm
Material	Plastic/Metal
IP Class	IP65, Class 3
Cable	Black 150 cm replaceable, Switch on fixture
Light source	Fixed LED, Incl. 4,8W LED, Incl. 3-Step MOODMAKER™, Lumen 300, Kelvin 2700, Life hours 30.000, RA 80, Beam angle 120°, Dimmable

Features

- Long life battery
- High lumen output with 3 step dimming
- 5 year LED guarantee
- Warm white LED 2700 Kelvin
- Handle for easy bring along



Long life battery



Step dimming on the product



USB charge

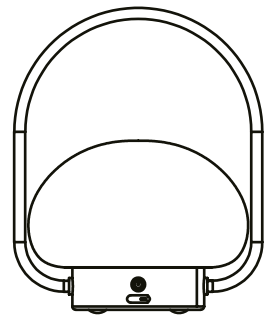

22,5cm

27,7cm



White
2018135003



Sponge 20 Table by Says Who

Masterbox	Qty 3
Size	H: 21,5 cm, W: 20 cm, L: 20 cm, Ø: 20 cm, Pipe Ø: 2,3 cm
Material	Plastic/Metal
IP Class	IP65, Class 3
Light source	Fixed LED, Incl. 4,8W LED, Incl. 3-Step MOODMAKER™, Lumen 300, Kelvin 2700, Life hours 30.000, RA 80, Beam angle 120°, Dimmable

Features

- Long life battery
- Durable materials
- High lumen output with 3 step dimming
- 5 year LED guarantee
- Warm white LED 2700 Kelvin



Long life battery



Step dimming on the product



USB charge

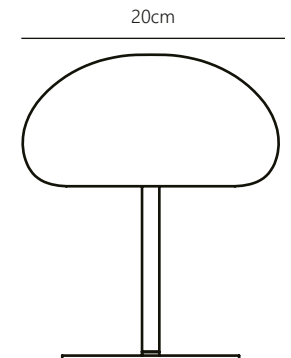

21,5cm

20cm

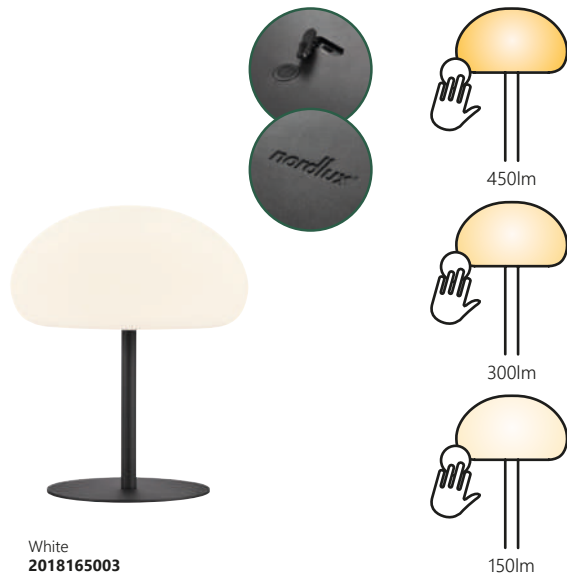

Sponge 34 Table by Says Who

Masterbox	Qty 3
Size	H: 40,5 cm, W: 34 cm, L: 34 cm, Ø: 34 cm, Pipe Ø: 2,3 cm
Material	Plastic/Metal
IP Class	IP65, Class 3
Light source	Fixed LED, Incl. 6,8W LED, Incl. 3-Step MOODMAKER™, Lumen 450, Kelvin 2700, Life hours 30.000, RA 80, Beam angle 120°, Dimmable

Features

- Long life battery
- Durable materials
- High lumen output with 3 step dimming
- 5 year LED guarantee
- Warm white LED 2700 Kelvin
- Big size and 450 Lumen

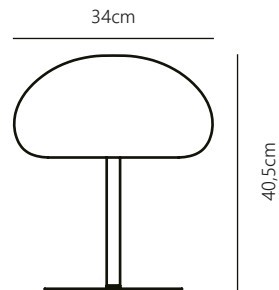

Sponge 34 Floor by Says Who

Masterbox	Qty 3
Size	H: 126 cm, W: 34 cm, L: 34 cm, Ø: 34 cm, Pipe Ø: 2,3 cm, Base Ø: 28,5 cm
Material	Plastic/Metal
IP Class	IP65, Class 3
Light source	Fixed LED, Incl. 6,8W LED, Incl. 3-Step MOODMAKER™, Lumen 450, Kelvin 2700, Life hours 30.000, RA 80, Beam angle 120°, Dimmable

Features

- Long life battery
- Durable materials
- High lumen output with 3 step dimming
- 5 year LED guarantee
- Warm white LED 2700 Kelvin
- Big size and 450 Lumen

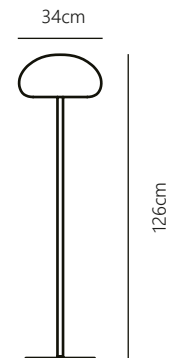



Watch the full ambience video and explore the functionalities of the Kettle series



Kettle



Kettle 36 by Says Who

Masterbox	Qty 3
Size	H: 30,8 cm, W: 36 cm, L: 36 cm, Ø: 36 cm
Material	Plastic/Plastic
IP Class	IP65, Class 3
Cable	Black 150 cm replaceable, Switch on fixture
Light source	Fixed LED, Incl. 6,8W LED, Incl. 3-step dimmer, Lumen 450, Kelvin 2700, Life hours 30.000, RA 80, Beam angle 120°, Dimmable

Features

- Long life battery
- High lumen output with 3 step dimming
- 5 year LED guarantee IP65 water resistant
- Warm white LED 2700 Kelvin
- Easy twist mount accessories for placement



Long life battery



Step dimming on the product



USB charge

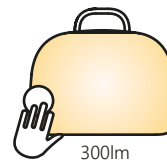
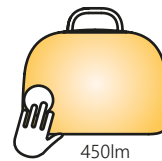
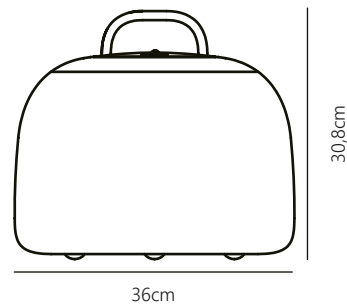



White
2018003003

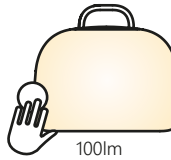
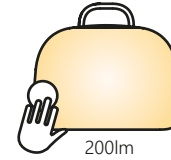
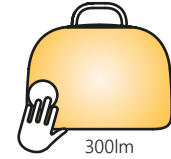

Black
2018028003

Kettle 22 by Says Who

Masterbox	Qty 3
Size	H: 19,6 cm, W: 22 cm, L: 22 cm, Ø: 22 cm
Material	Plastic/Plastic
IP Class	IP65, Class 3
Cable	Black 150 cm replaceable, Switch on fixture
Light source	Fixed LED, Incl. 4,8W LED, Incl. 3-step dimmer, Lumen 300, Kelvin 2700, Life hours 30.000, RA 80, Beam angle 120°, Dimmable

Features

- Long life battery
- High lumen output with 3 step dimming
- 5 year LED guarantee
- Warm white LED 2700 Kelvin
- Easy twist mount accessories for placement



Long life battery



Step dimming on the product



USB charge

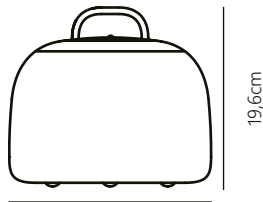

22cm

19,6cm

Kettle Spike by Says Who

Masterbox	Qty 3
Size	H: 51,6 cm, W: 5,8 cm, L: 5,8 cm, Pipe Ø: 1,8 cm
Material	Metal/Aluminium

Features

- Easy twist mount accessory for Kettle luminaire
- Metal spike



5,8cm

51,6cm



Black
2018035003

FSC Wood
2018035014

Kettle Tripod 31 by Says Who

Masterbox Qty 3
Size H: 34,4 cm, W: 17,9 cm, L: 15,7 cm, Pipe Ø: 1,6 cm
Material Metal - Wood/Metal

Features
 Easy twist mount accessory for Kettle luminaire
 Tripod turns it into table or low floor lamp

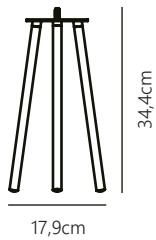

Black
2018044003

FSC Wood
2018044014

Kettle Tripod 100 by Says Who

Masterbox Qty 3
Size H: 102,9 cm, W: 36,7 cm, L: 32 cm, Pipe Ø: 1,6 cm
Material Metal - Wood/Metal

Features
 Easy twist mount accessory for Kettle luminaire
 High tripod turns it into floor lamp

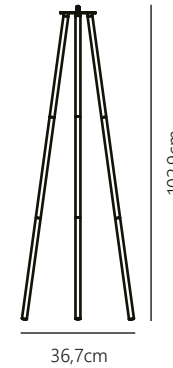

Campaign Collaboration

Instagram influencers posting their own content with Sponge and Kettle

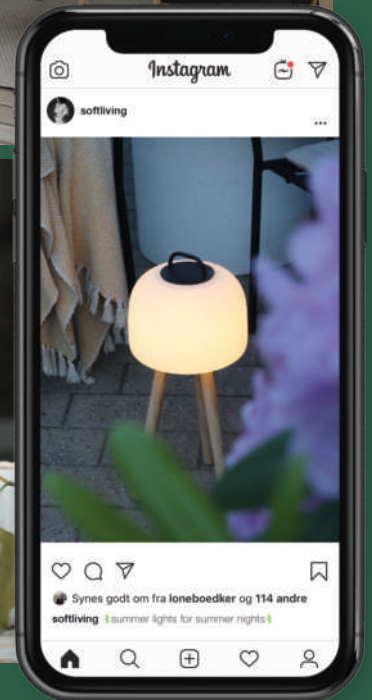

In Store Support

POS material is an effective tool for creating awareness and preferences among customers. In order to promote sales in the store and increase awareness of specific products or concepts, we offer you creative designs and solutions, including display solutions, signs, shelf danglers etc., which catch the customers' attention.

We take care of the process from idea to finished production. The effect of great POS material is not to be mistaken - see here what we can offer you.



Small table displays for your narrow spaces*



Display & pallet solutions for your assortment*



Space management for your assortment*

*FOR ILLUSTRATION ONLY

Marketing Support

This year, we have made it easy for you to retrieve all the marketing material you need for our Take Me Anywhere assortment. You will find ready-to-use ambience photos and pack shots **right here**.

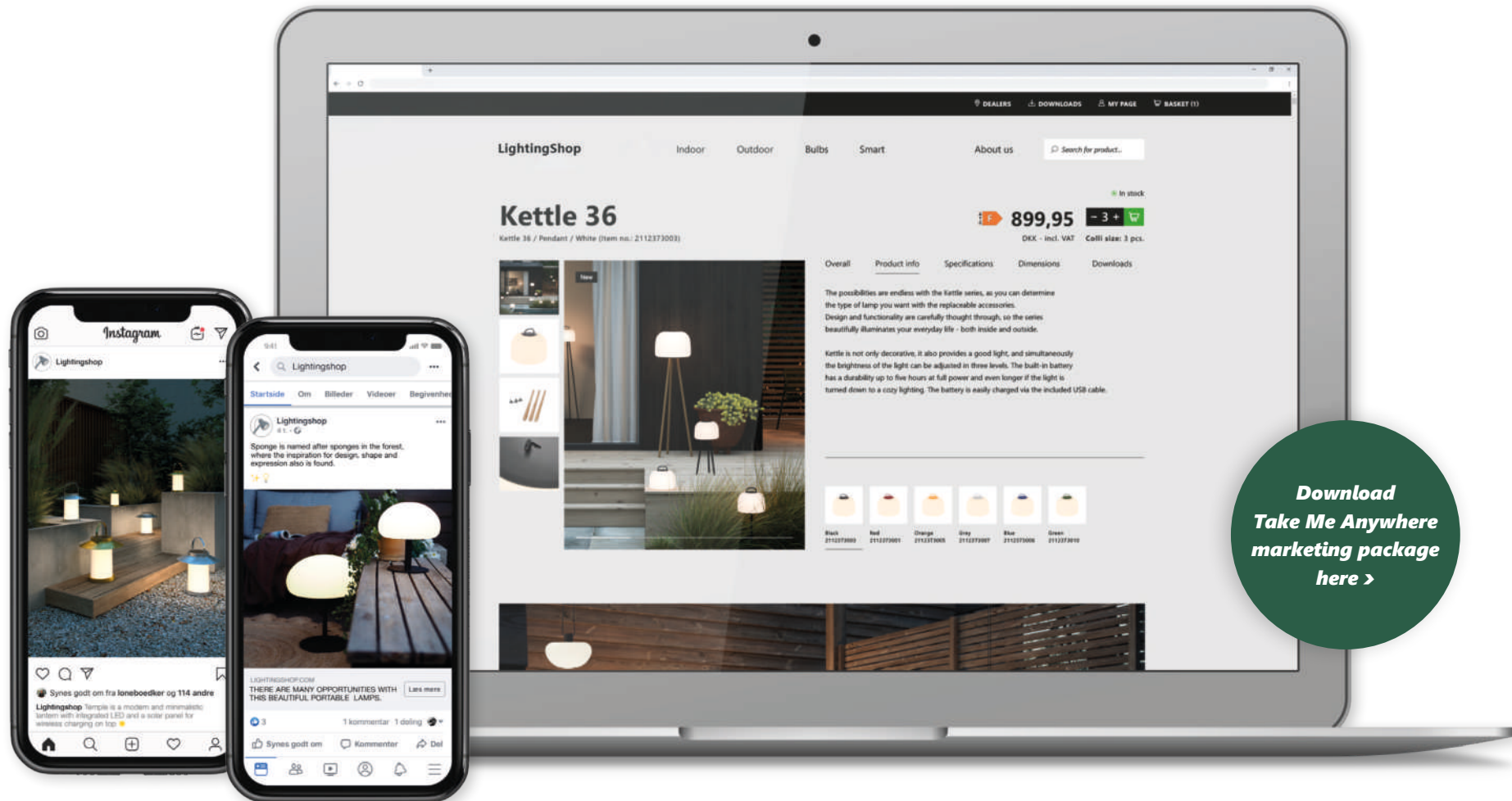

**Download
Take Me Anywhere
marketing package
here >**

Showroom & Headquarters

Østre Havnegade 34
DK 9000 Aalborg
T + 45 98 18 16 11
nordlux@nordlux.com
nordlux.com

Benelux & Portugal

T +32 (0)15 25 76 40
info@nordlux.com

France

T +33 320 479 346
france@nordlux.com

Germany

T +49 (0) 21 52 89 87 37
F +49 (0) 21 52 14 85 54
germany@nordlux.com

Norway

T +47 51 88 63 18
norway@nordlux.com

Sweden

T +46 (0) 20 14 00 054
sweden@nordlux.com

UK & Eire

T +44 (0) 12 00 42 27 77
salesuk@nordlux.com

Der tages forbehold for ændringer m.h.t. tekniske specifikationer, design og collistørrelser.

Vi förbehåller oss för ändring med hänsyn till tekniske specifikationer, design och collistorlek.

We reserve the right to changes as to technical specifications, design and number of packages.

Wir nehmen Vorbehalt für Änderungen bezgl. technischer Spezifikationen, Design und Verpackungseinheiten.

Nous nous réservons le droit de modifier toute documentation technique, design et colisage.

We behouden ons het recht om technische specificaties, ontwerp en verpakingsaantal te wijzigen zonder voorafgaande kennisgeving.

nordlux[®]

nordlux.com

instagram **@nordlux**

pinterest **@nordlux**